

NS060

Light Sensor



Specifications

Change History

Document Version	Release Date	Description
V1.1.2	2022-03-11	<ul style="list-style-type: none"> • Added the certification related description. • Added the IP rating information.
V1.1.1	2021-02-06	Added the certification information.
V1.1.0	2020-05-22	Updated the cable length description.

Introduction

The NS060 is a light sensor designed and produced by NovaStar. It can be connected to NovaStar sending cards, asynchronous cards or multifunction cards for ambient brightness monitoring, allowing for automatic brightness adjustment of LED display.

The sensor body of NS060 is made of aluminum alloy. The sensor surface adopts micro-arc oxidation process, and therefore it is highly UV-resistant and will not be discolored. The joint between the sensor body and the male connector has a very deep groove and is extremely waterproof.

Certifications

EMC, RoHS, PFOS

If the product does not have the relevant certifications required by the countries or regions where it is to be sold, please contact NovaStar to confirm or address the problem. Otherwise, the customer shall be responsible for the legal risks caused or NovaStar has the right to claim compensation.

Features

- Ambient brightness monitoring, allowing for automatic brightness adjustment of LED display
- Capable of connecting to sending cards (MSD300, MSD600, MCTRL300, etc.), asynchronous cards or multifunction cards
- Different cable lengths: 5 meters (NS060-5A model), 10 meters (NS060-10A model)
- Mildew, moisture and salt-mist resistant design, ideal for outdoor applications
- No external power supply required

Applications

The NS060 light sensor can work with devices that have light sensor connectors, such as sending cards, asynchronous cards and multifunction cards. It must be placed in the same environment with the LED display.

The connection between the light sensor and multifunction card is shown in [Figure 1](#).

Figure 1 Connection between NS060 and MFN300 multifunction card

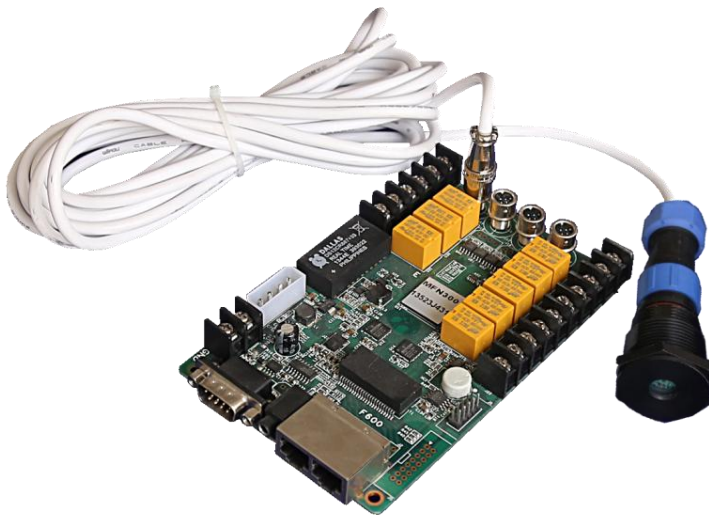

Dimensions

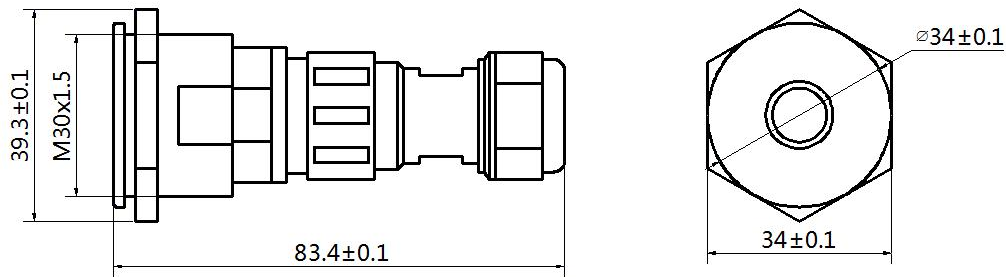

Unit: mm

Assembly

Preparation

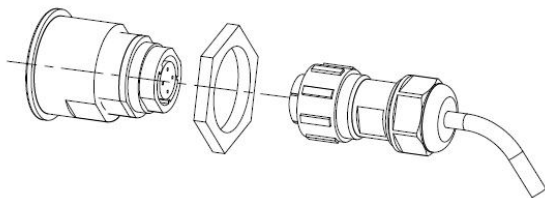

Assembly

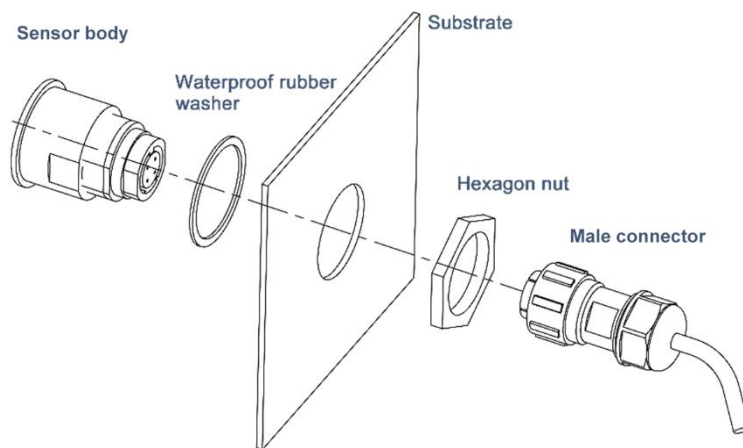

Complete

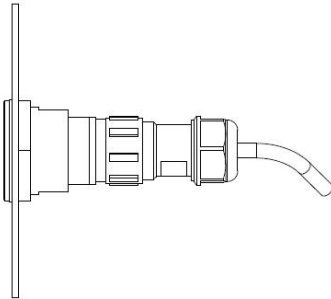

Tips: It is recommended that you apply outdoor waterproof adhesive to the joint between the sensor body and substrate after assembly, and check the joint regularly.

Specifications

Rated voltage	5 V DC
Operating temperature	-20°C to +70°C
Operating humidity	0% RH to 99% RH, non-condensing
Brightness measurement range	0 lux to 65535 lux
Cable length	5 m (NS060-5A model), 10 m (NS060-10A model)
IP rating	IP65

TECNOGROUP

LED TECHNOLOGY EXPERTS

Tel: +56 9 5449 1032
Email: contacto@tecnogroup.cl

Casa Matriz
Padre Hurtado Central 580
Las Condes, Santiago de Chile



www.tecnogroup.cl

 [@tecnogroup.cl](https://www.instagram.com/tecnogroup.cl)  [#tecnogroup.cl](https://www.facebook.com/tecnogroup.cl)  [Tecnogroup Chile](https://www.linkedin.com/company/tecnogroup)

Tel: 833 533 4255
Email: info@tecnogroup.us

Showroom Miami
759 NW. 24th ST.
Miami, FL 33127

www.tecnogroup.us

 [@tecnogroup.us](https://www.instagram.com/tecnogroup.us)  [#tecnogroup.us](https://www.facebook.com/tecnogroup.us)  [Tecnogroup USA](https://www.linkedin.com/company/tecnogroup)